

01-01

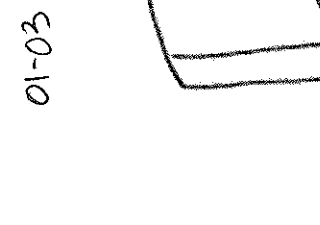

01-03

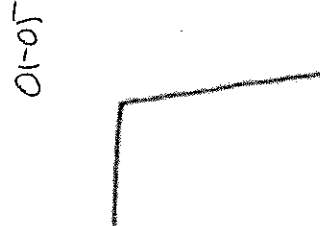

01-05

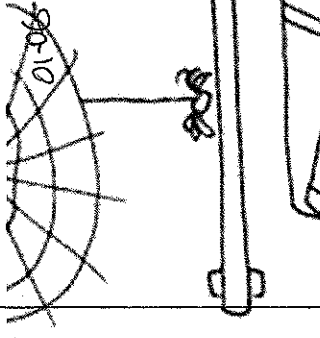

01-06

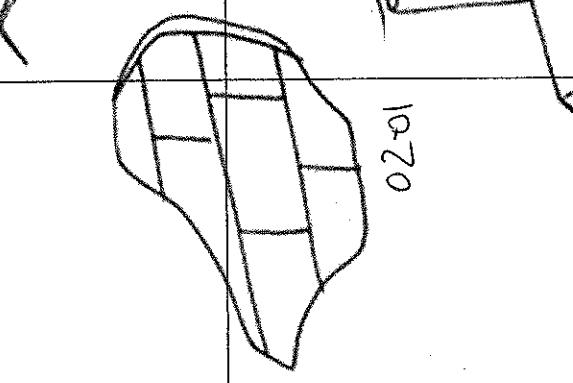

02-01

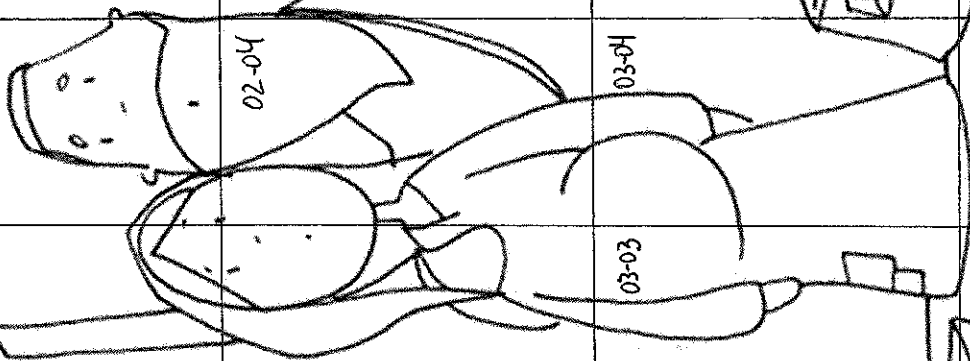

02-03

02-04

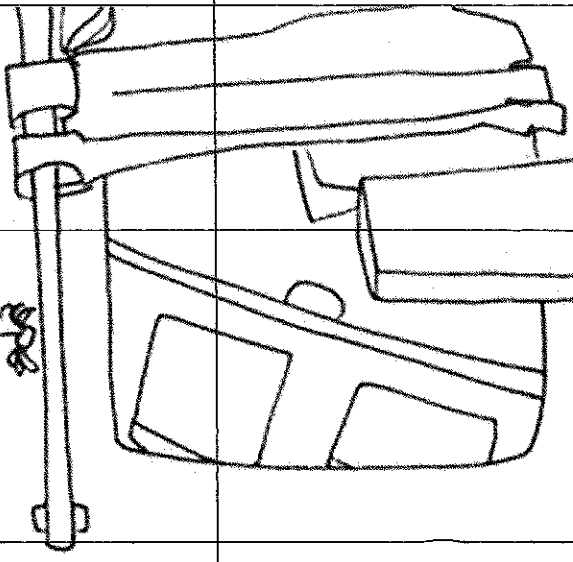

03-07

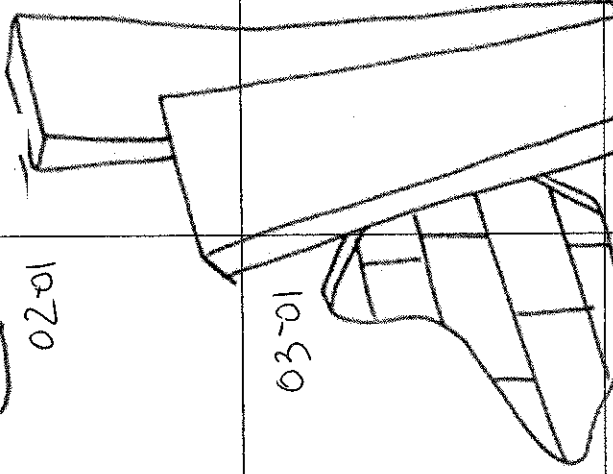

03-01

03-04

03-03

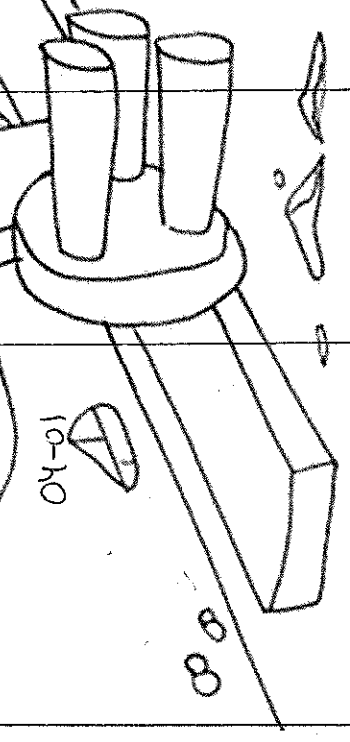

04-01

04-04

04-03

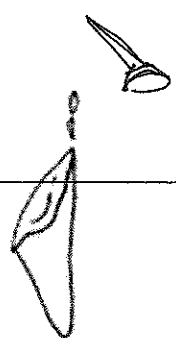
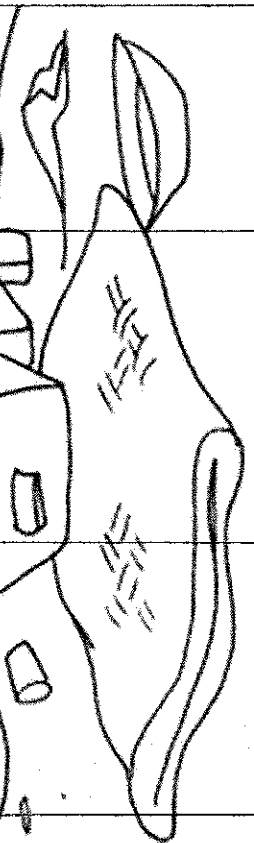

08 08

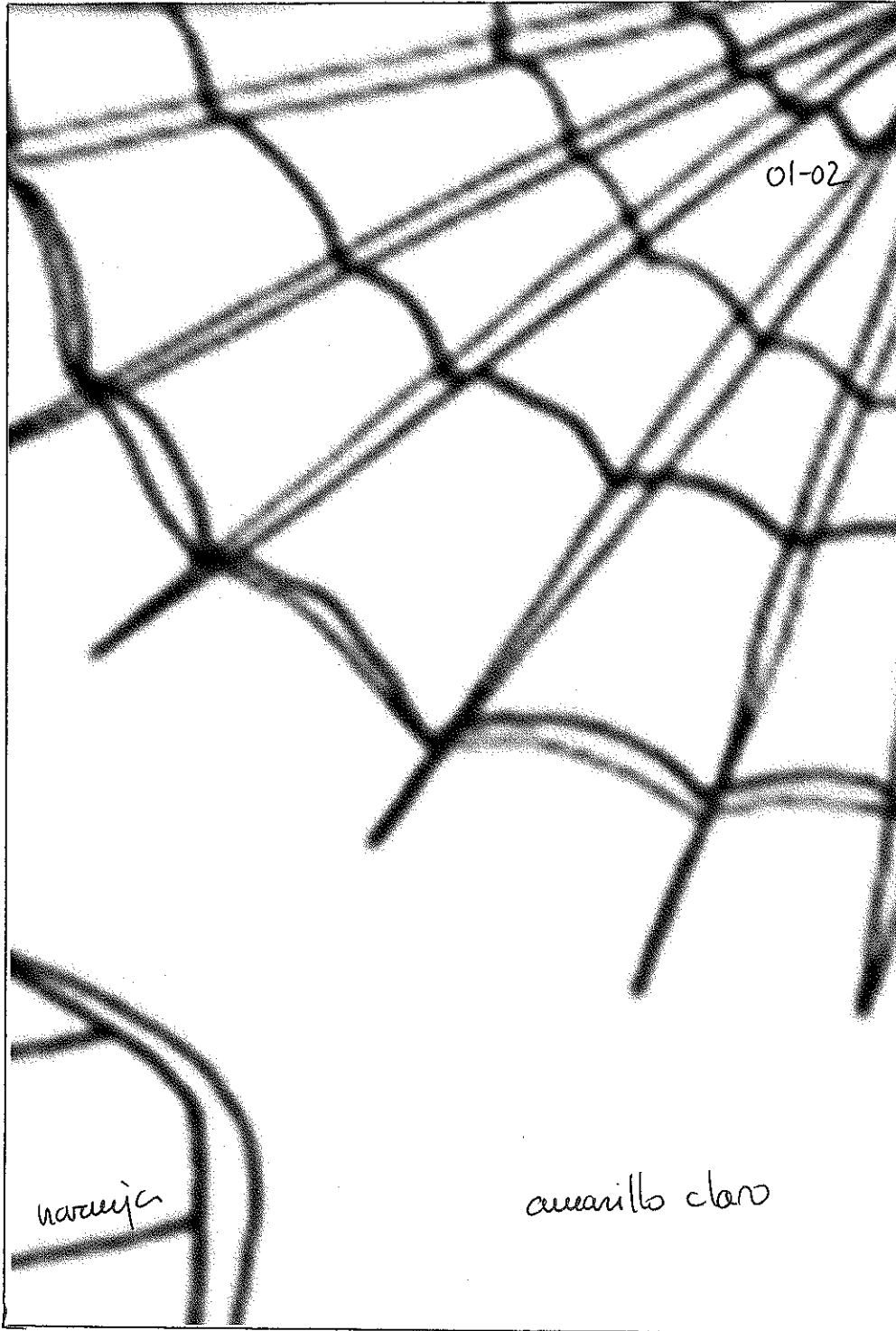

01-01

amarillo claro

narauja.

amarillo fuerte

01-03

amarillo claro

amarillo suave.

9261

amarillo fuerte

01-04

amarillo suave

sn's

azul →

sn's

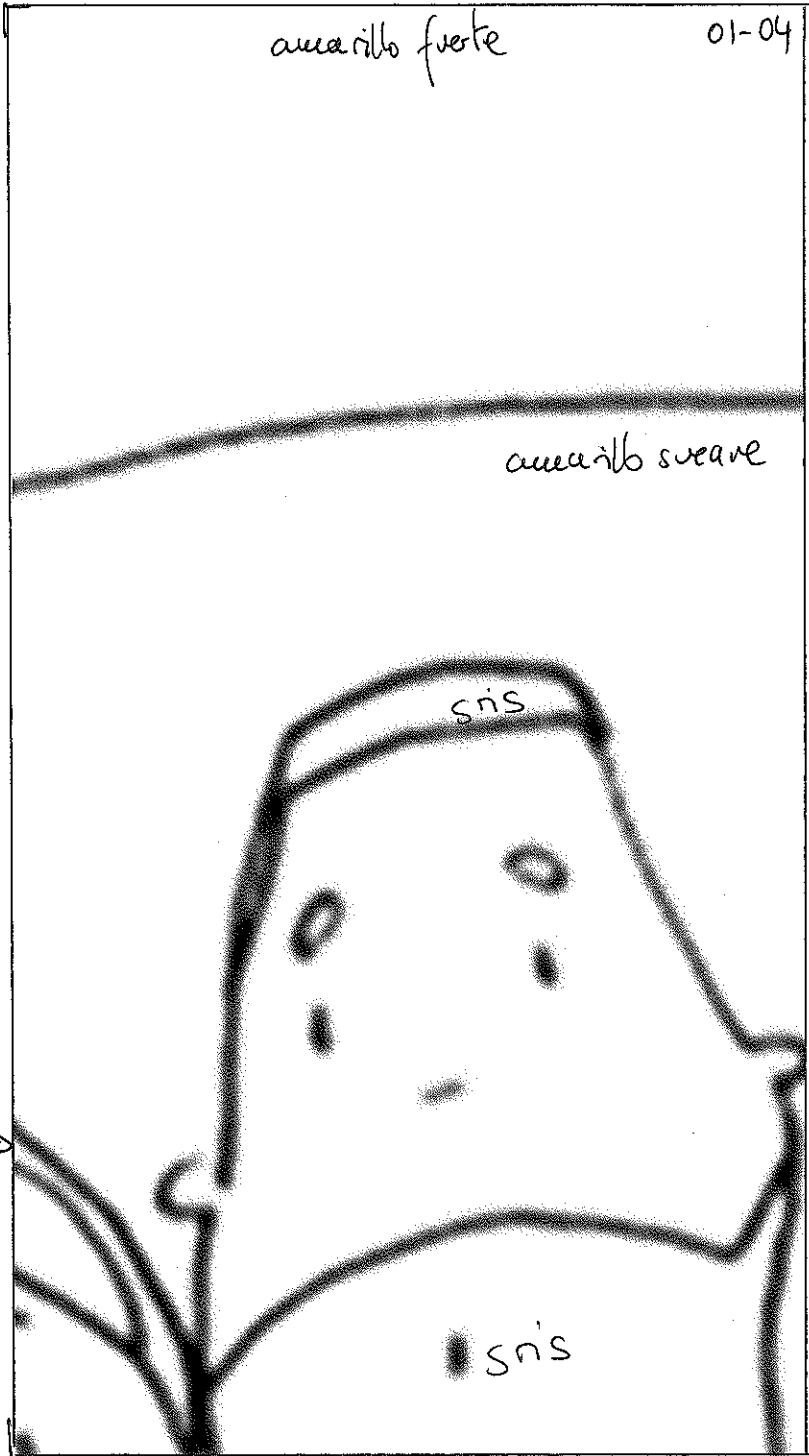

amarillo fuerte

01-05

amarillo  
suave

verde

verde

01-06

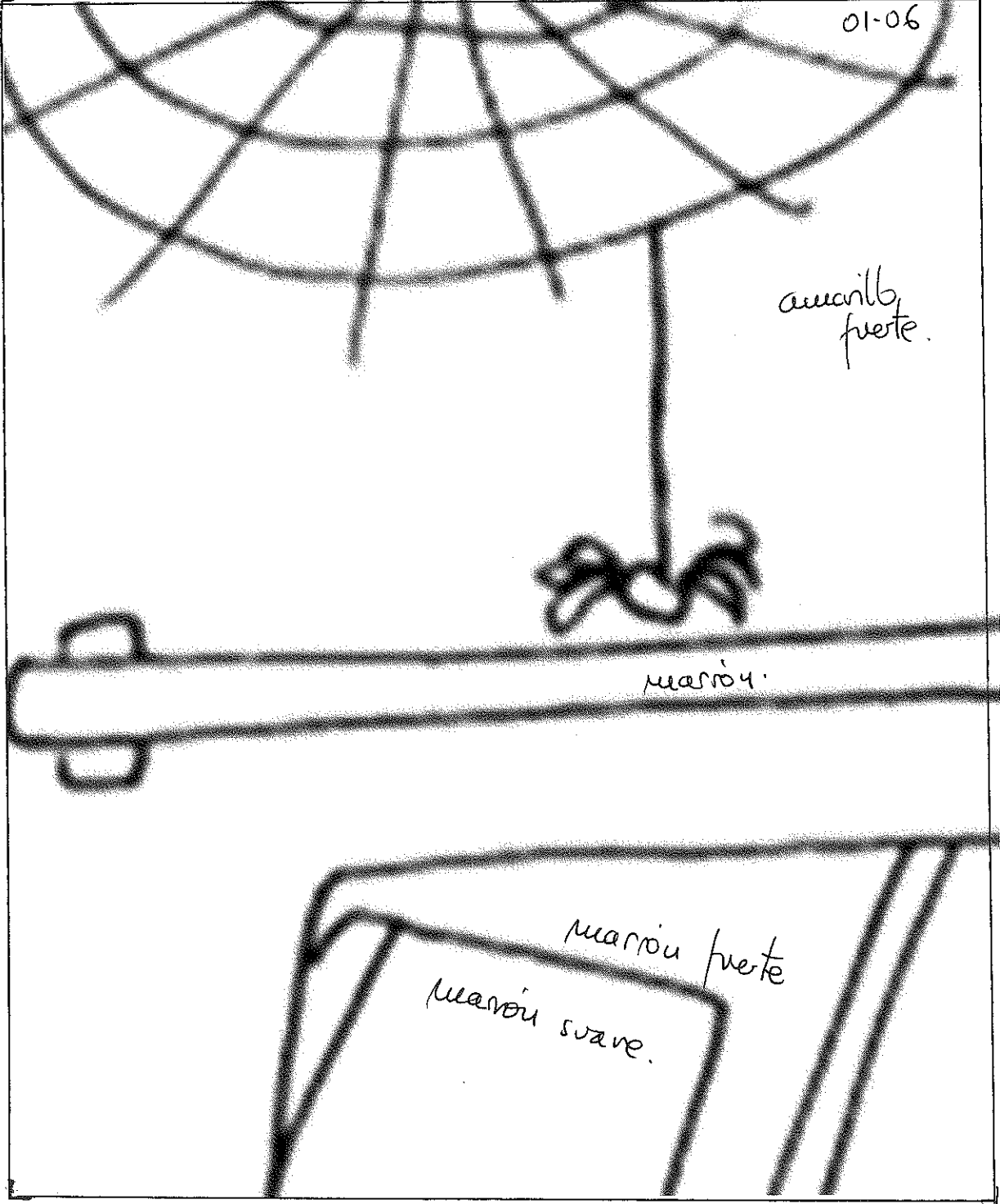

αυανίλλ,  
fuerte.

μαριόν.

μαριόν fuerte

μαριόν suave.

anailb forte

01-07

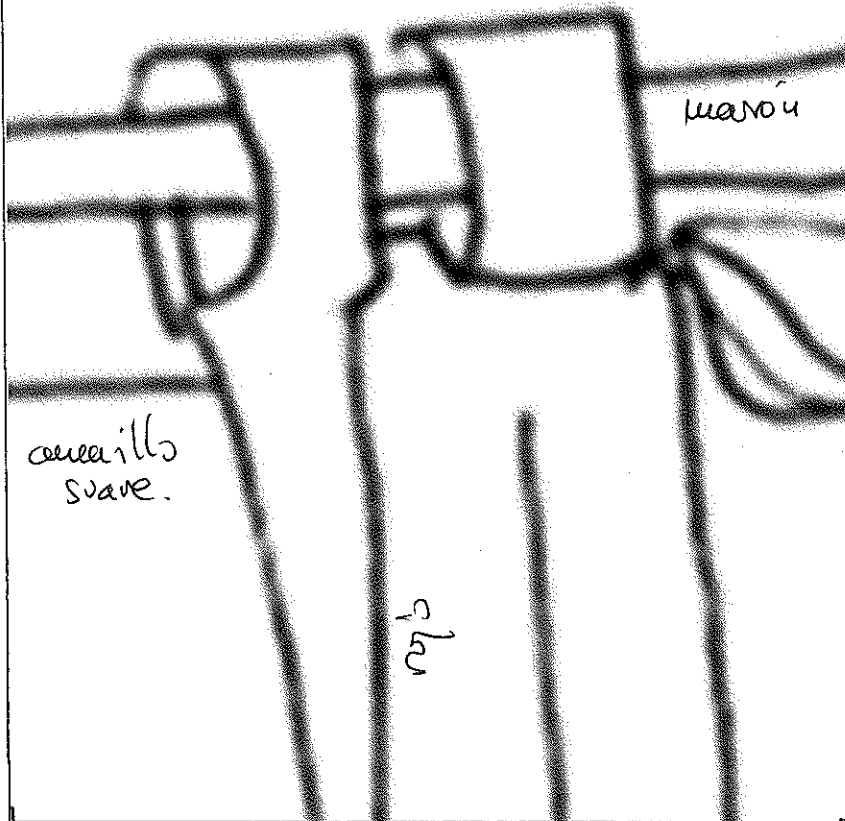

marón

anailb  
suave.

q'la



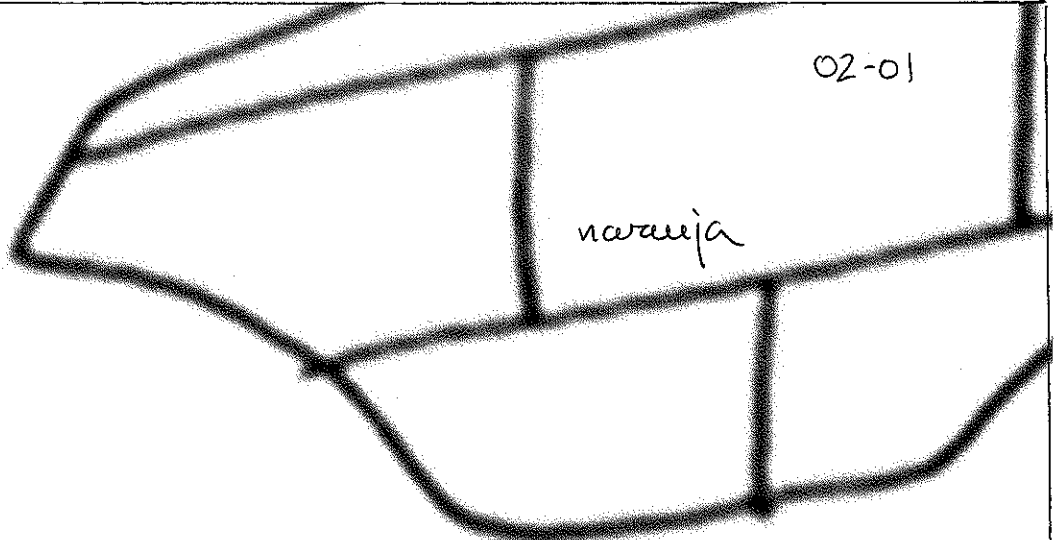

aurarillo clars

02-02  
αεραίοις κλαρο

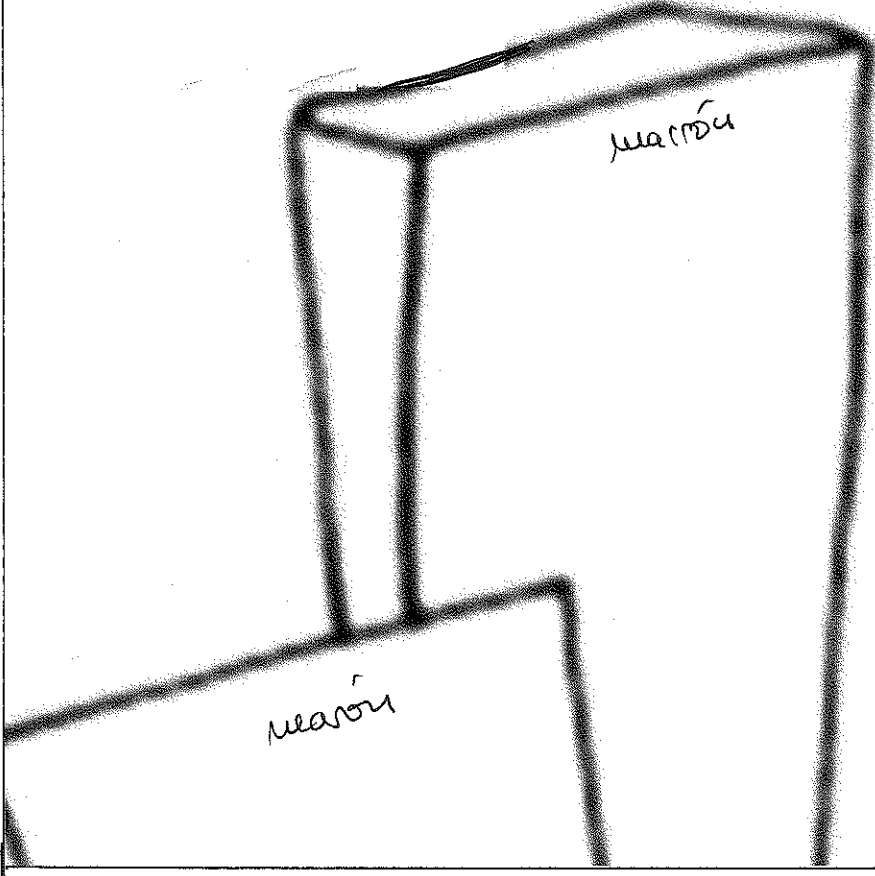

02-03

amarelo suave

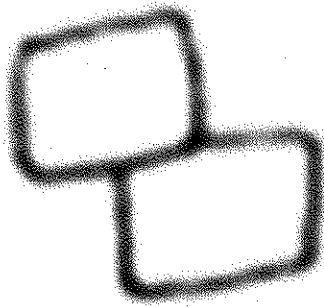

amarelo forte.

azul

castanho

verde claro

carne

rosa.

← carne

curve →  
↓



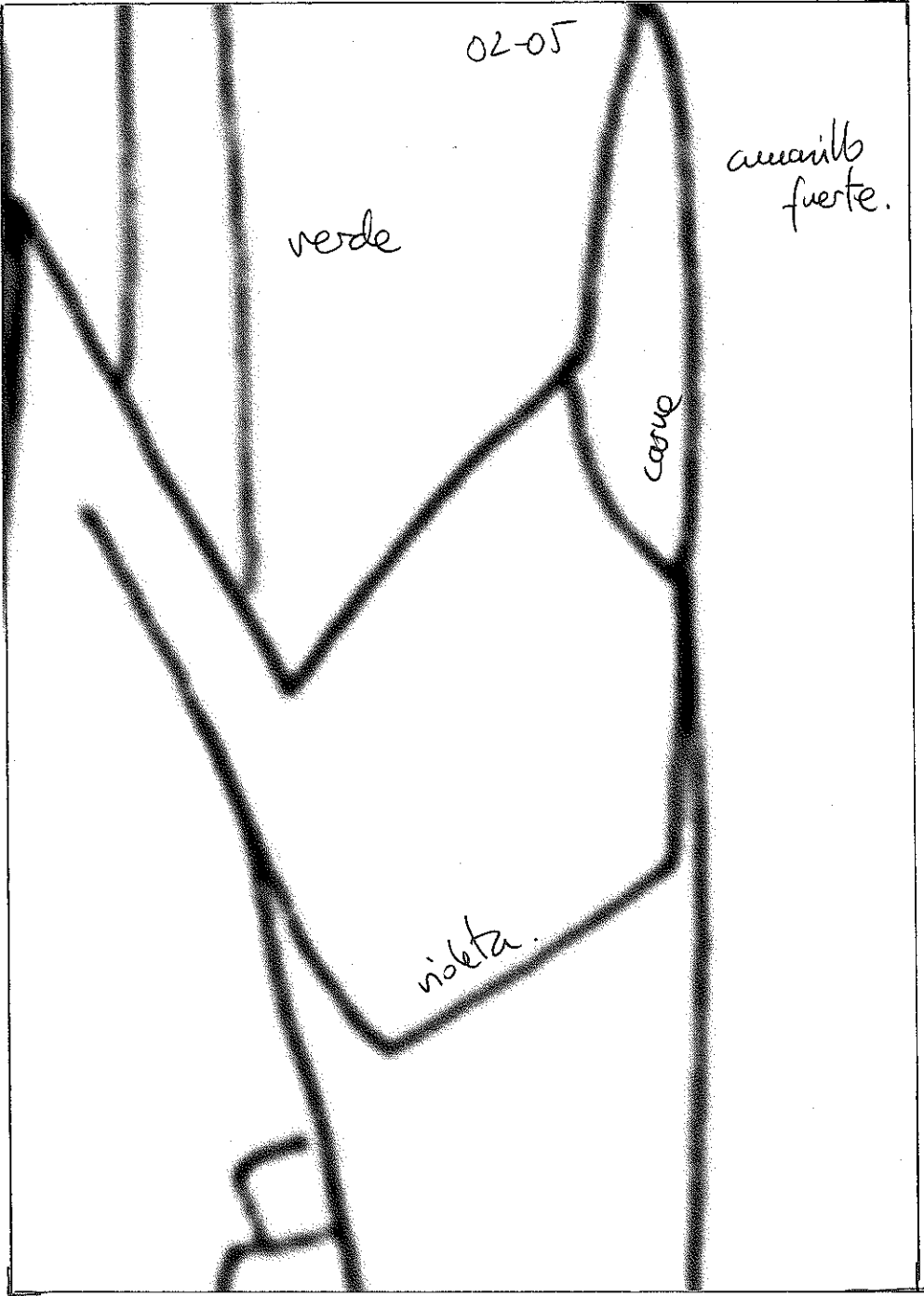

aurillo  
fuerte

02-06

aurillo  
suave

matón

matón

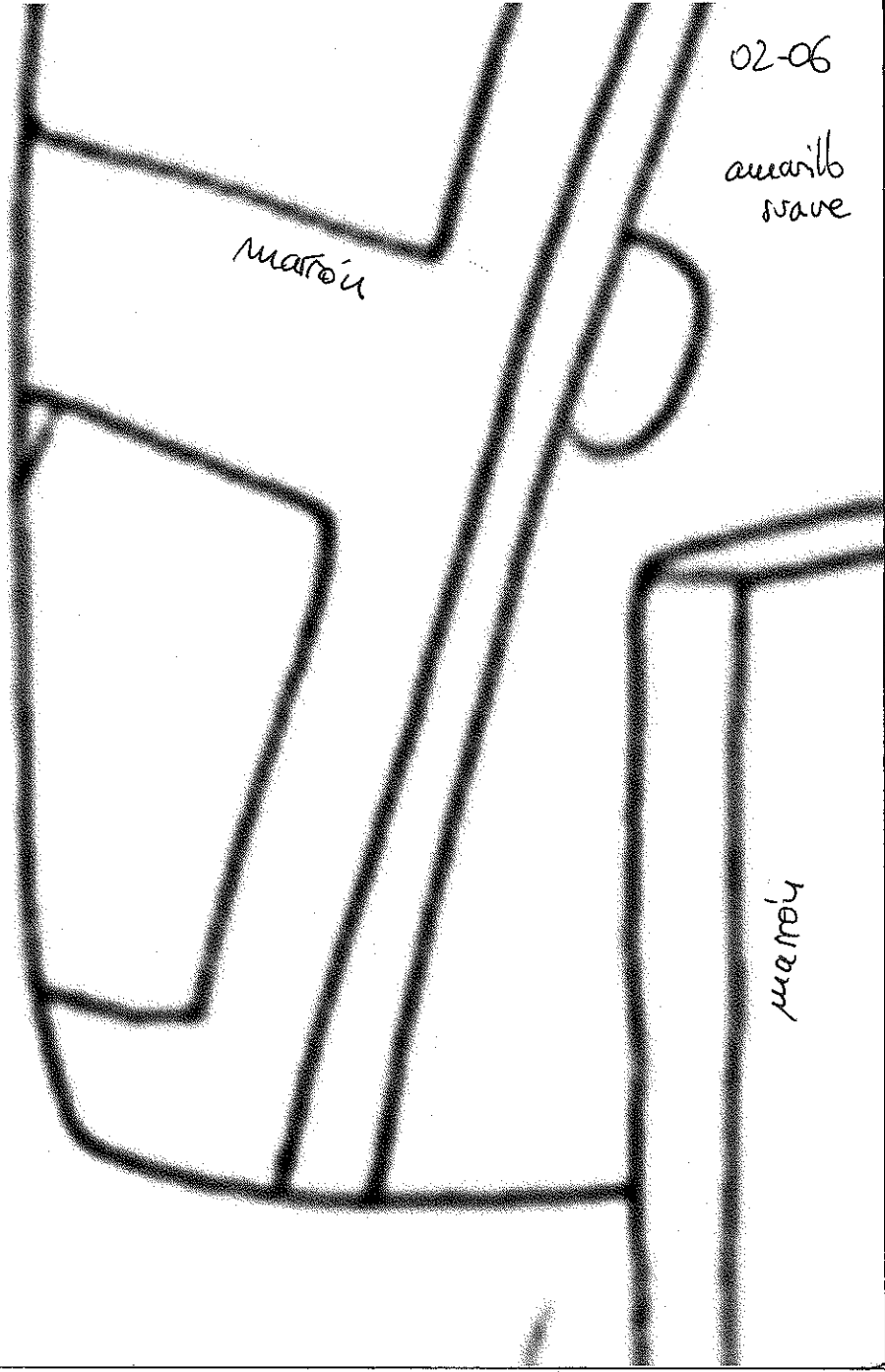

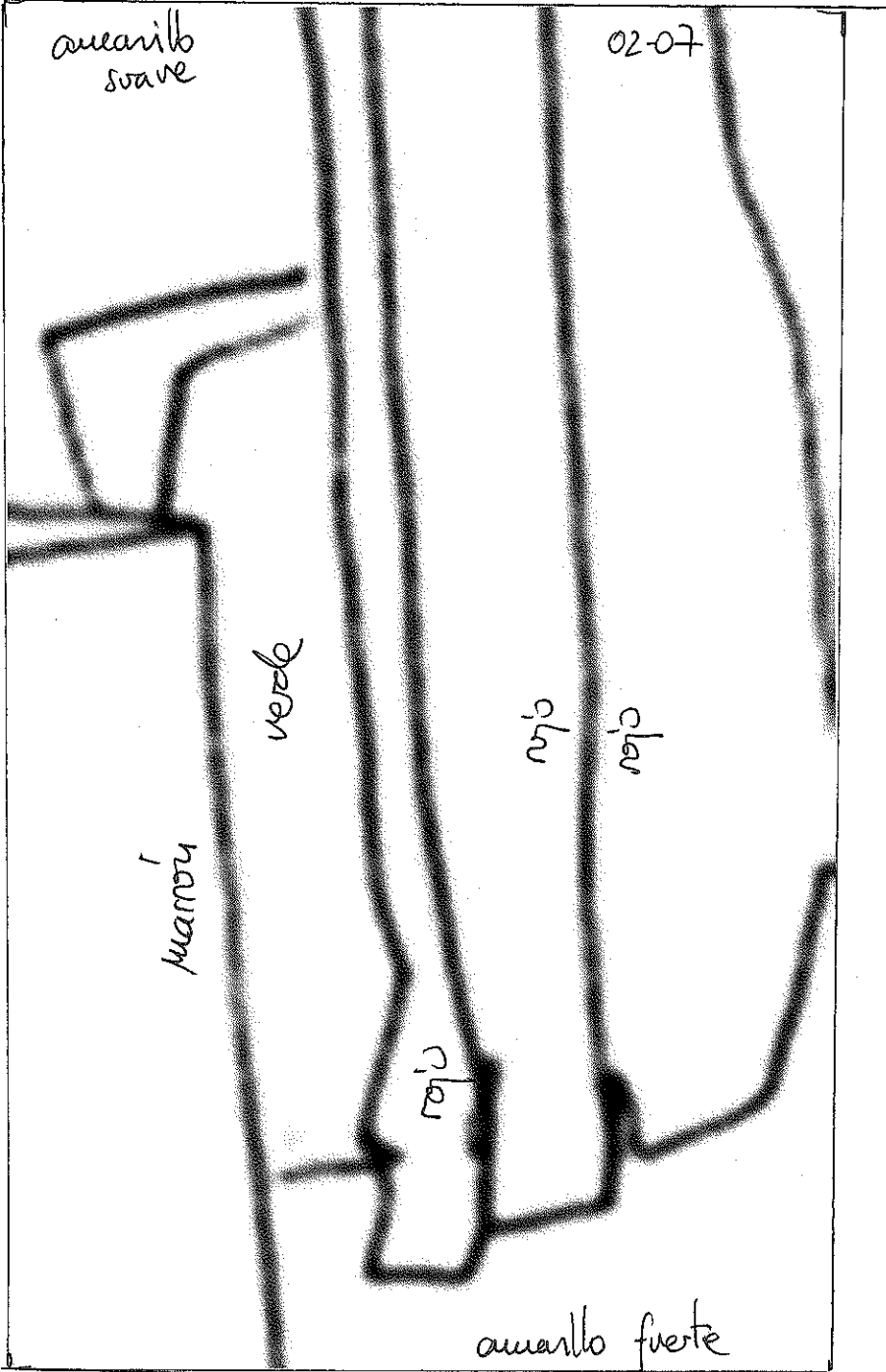

03-01

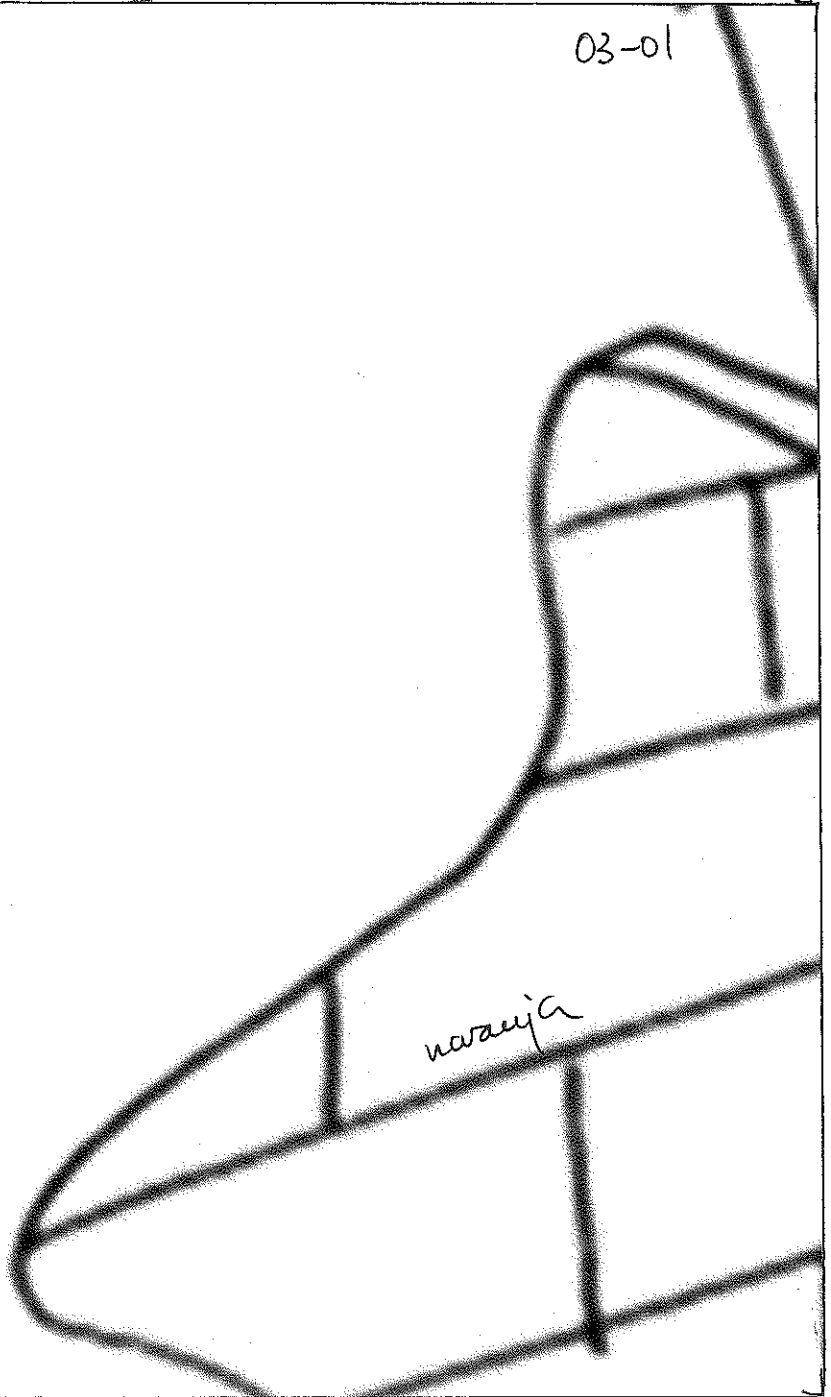

narauja

wearillo caro



μαρού

μαρού  
o

03-02

avariile clare

μαρού.

aurillo svave

03-03

rosa

rosa

casue

sns

mao'u

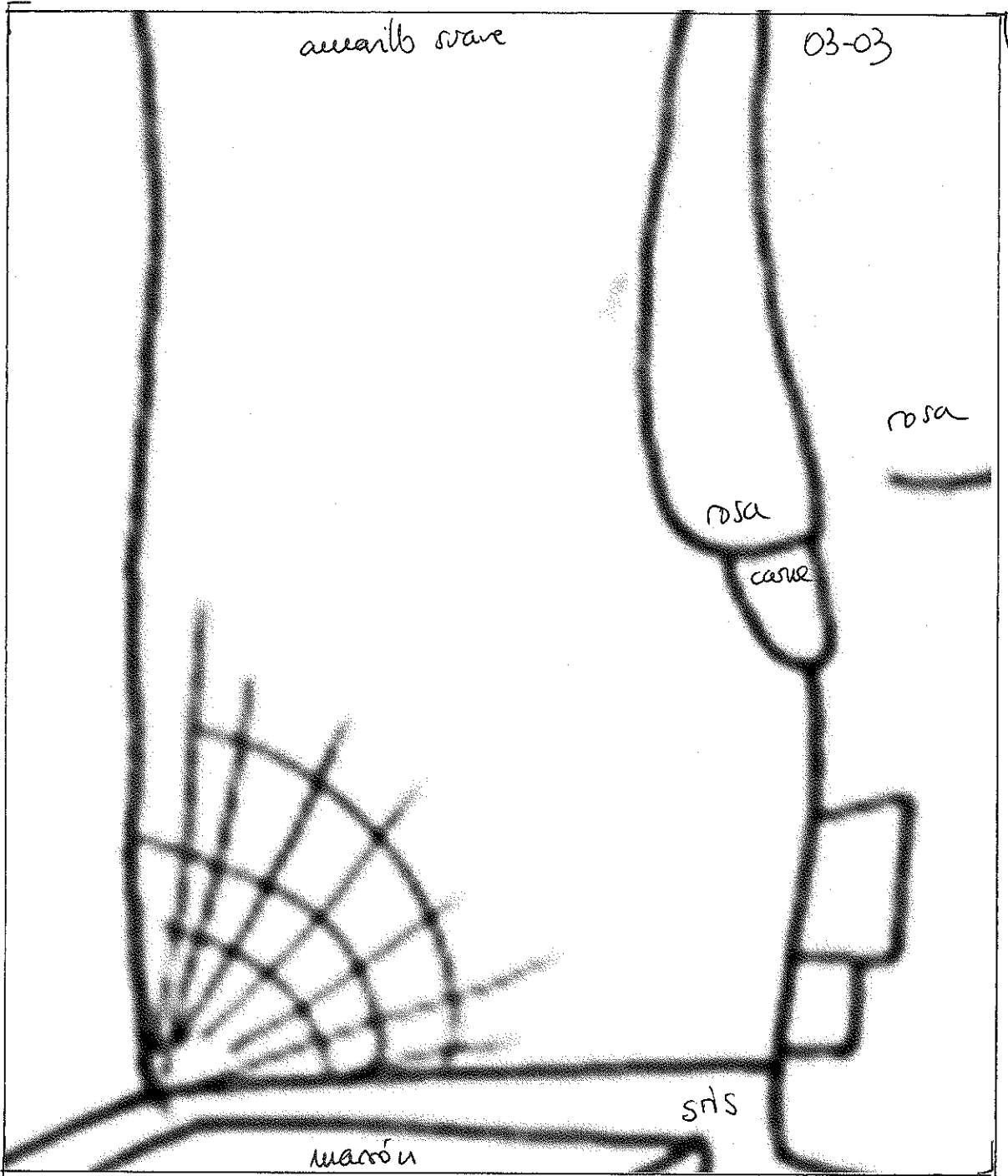

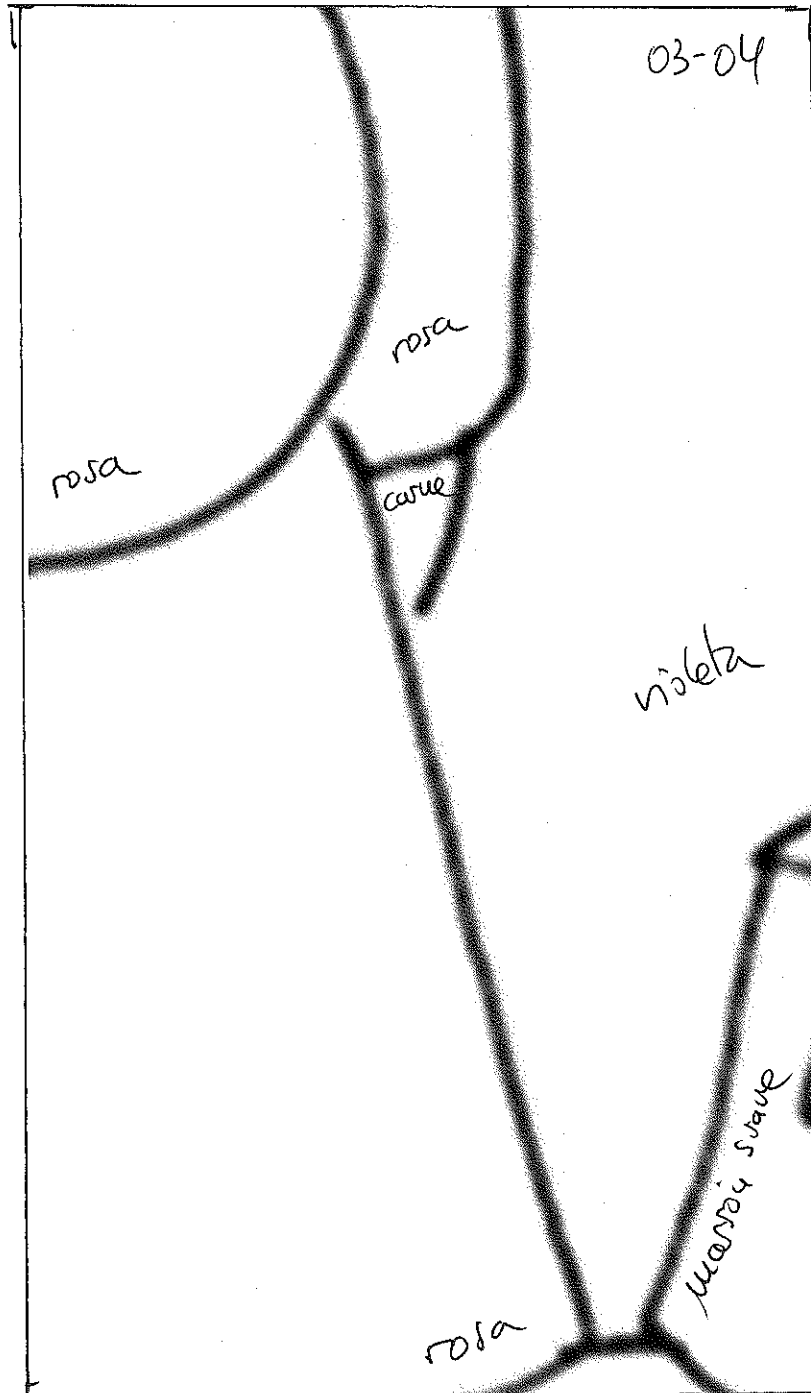

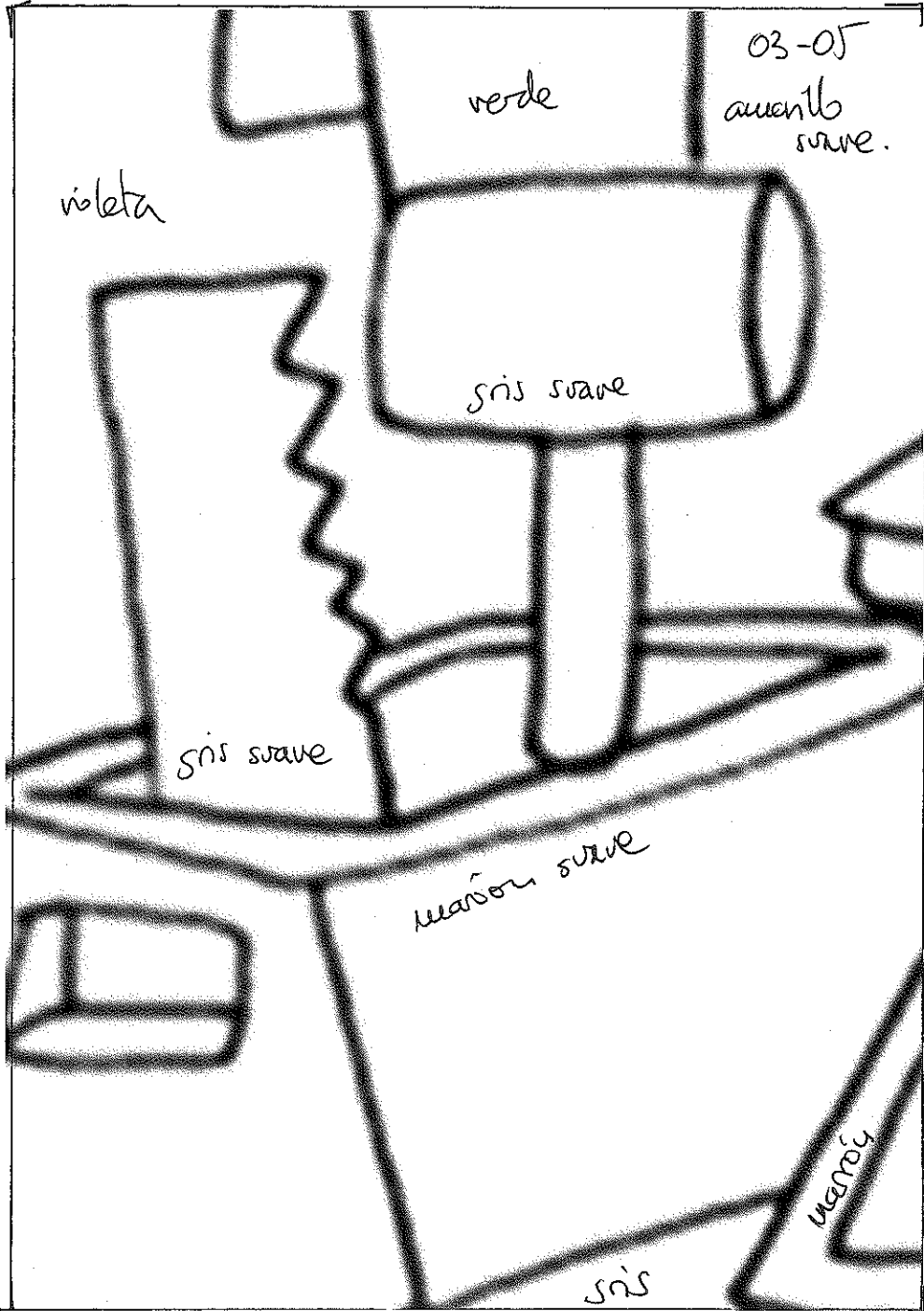

amarillo fuerte.

03-06

masón

amarillo pálido

masón

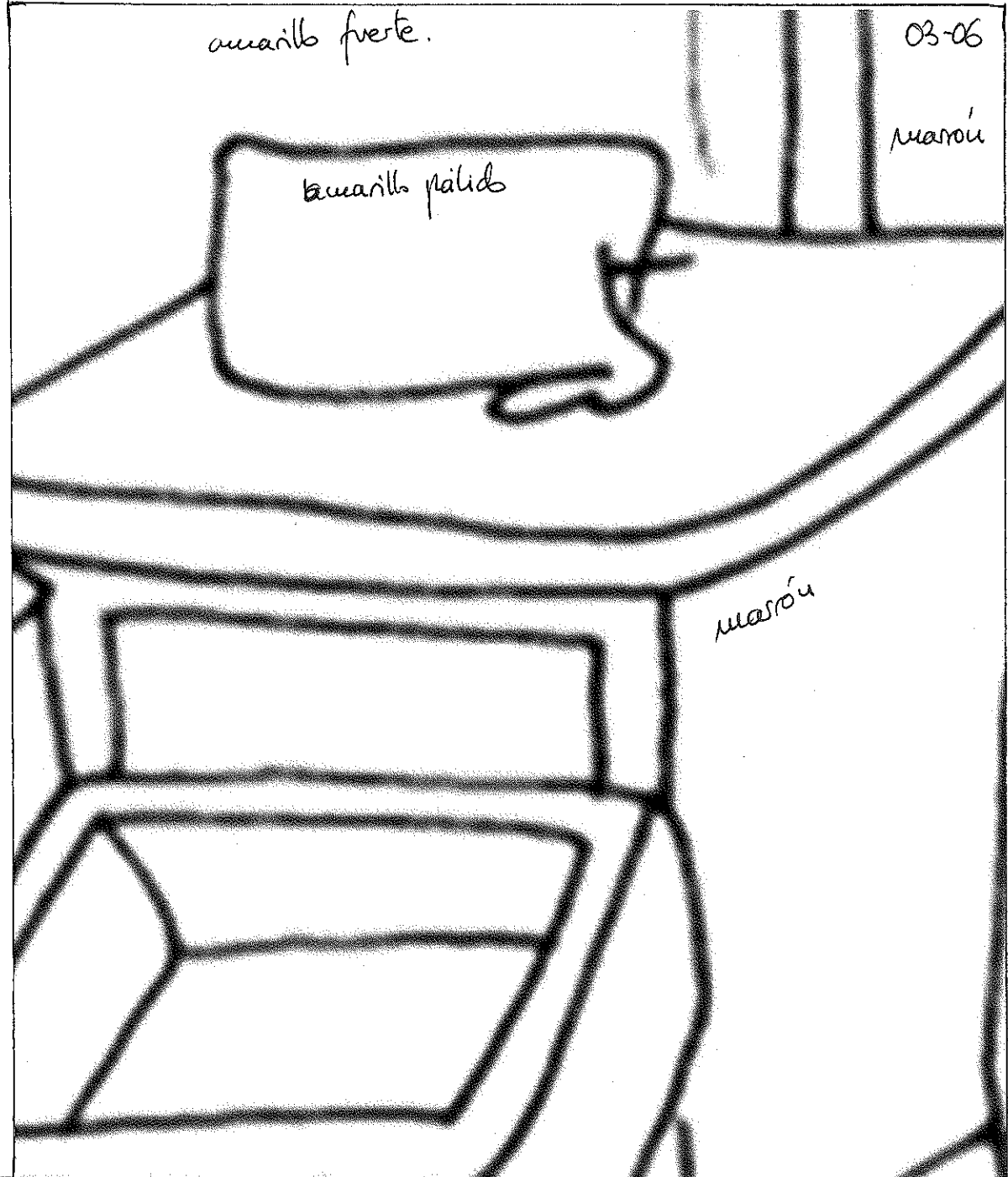

03-07

averillo  
fute

marón

escrito claro

04-01

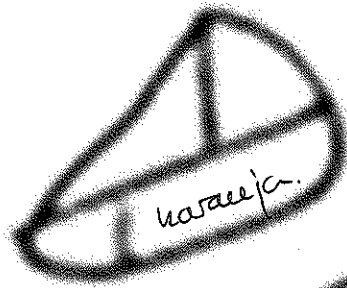

masou

sis

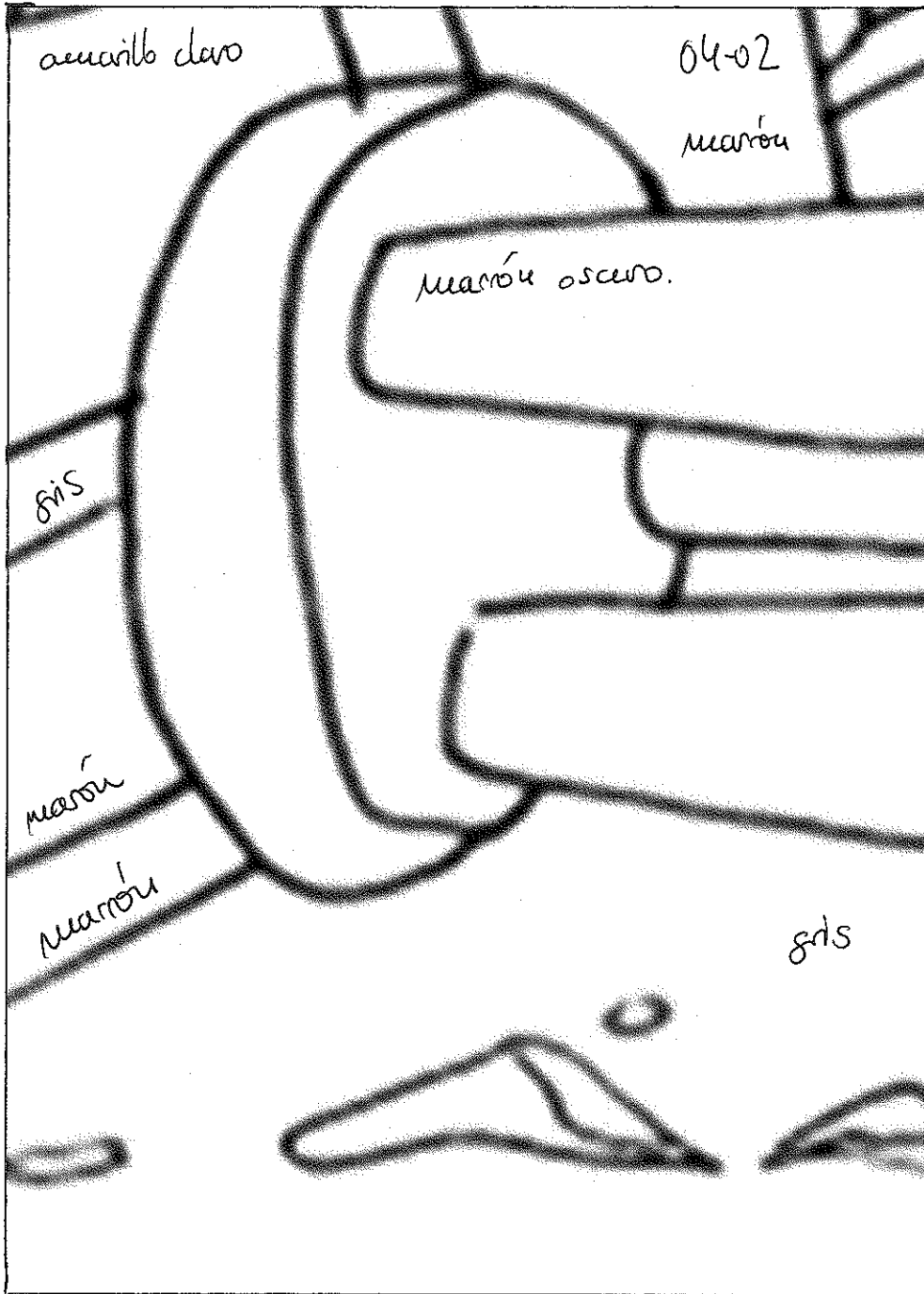



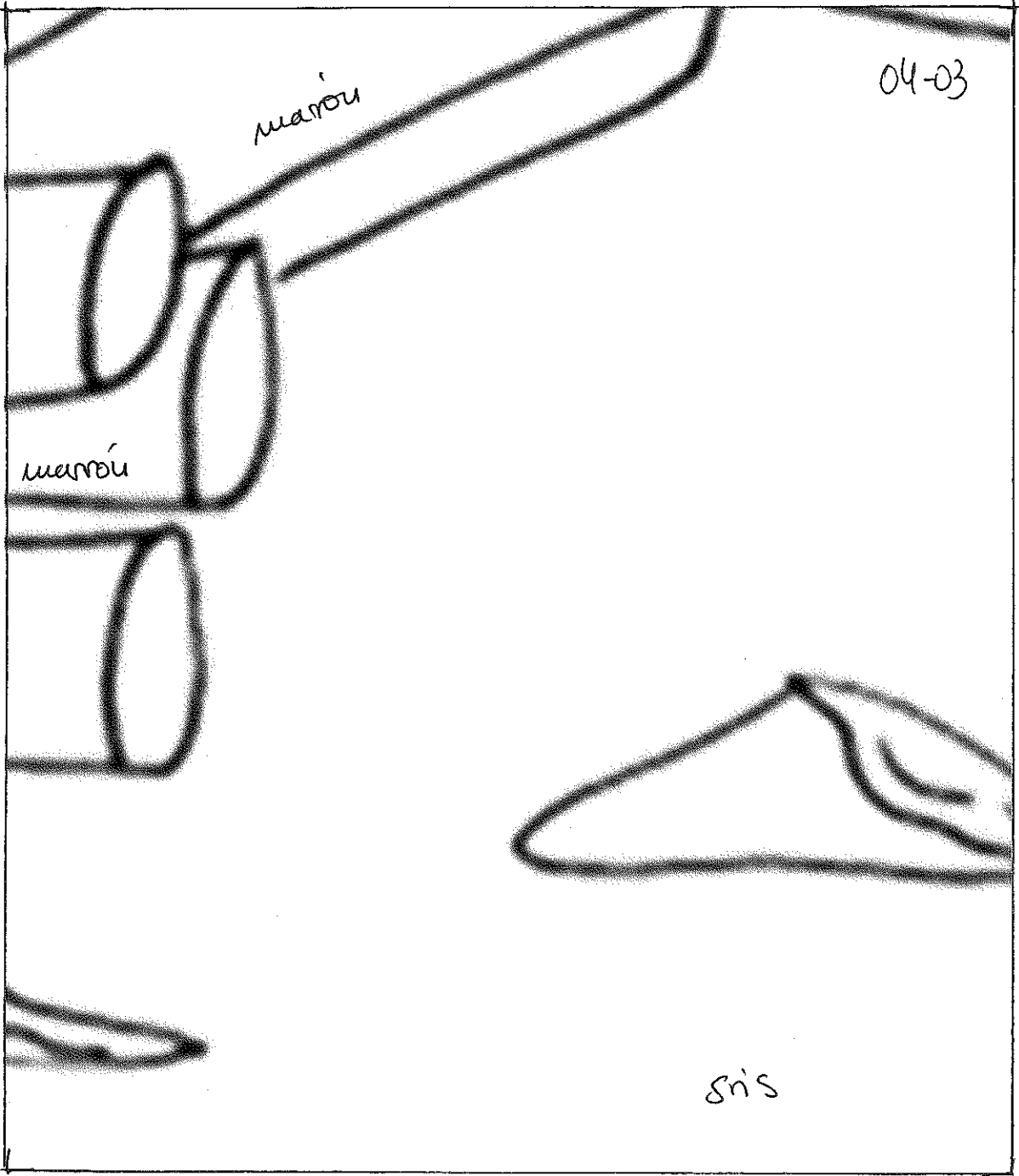

rosa

04-04

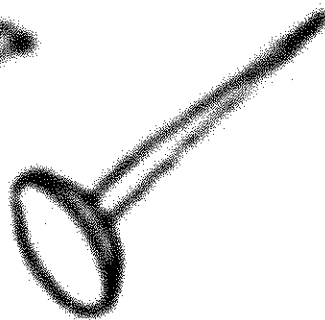

sis

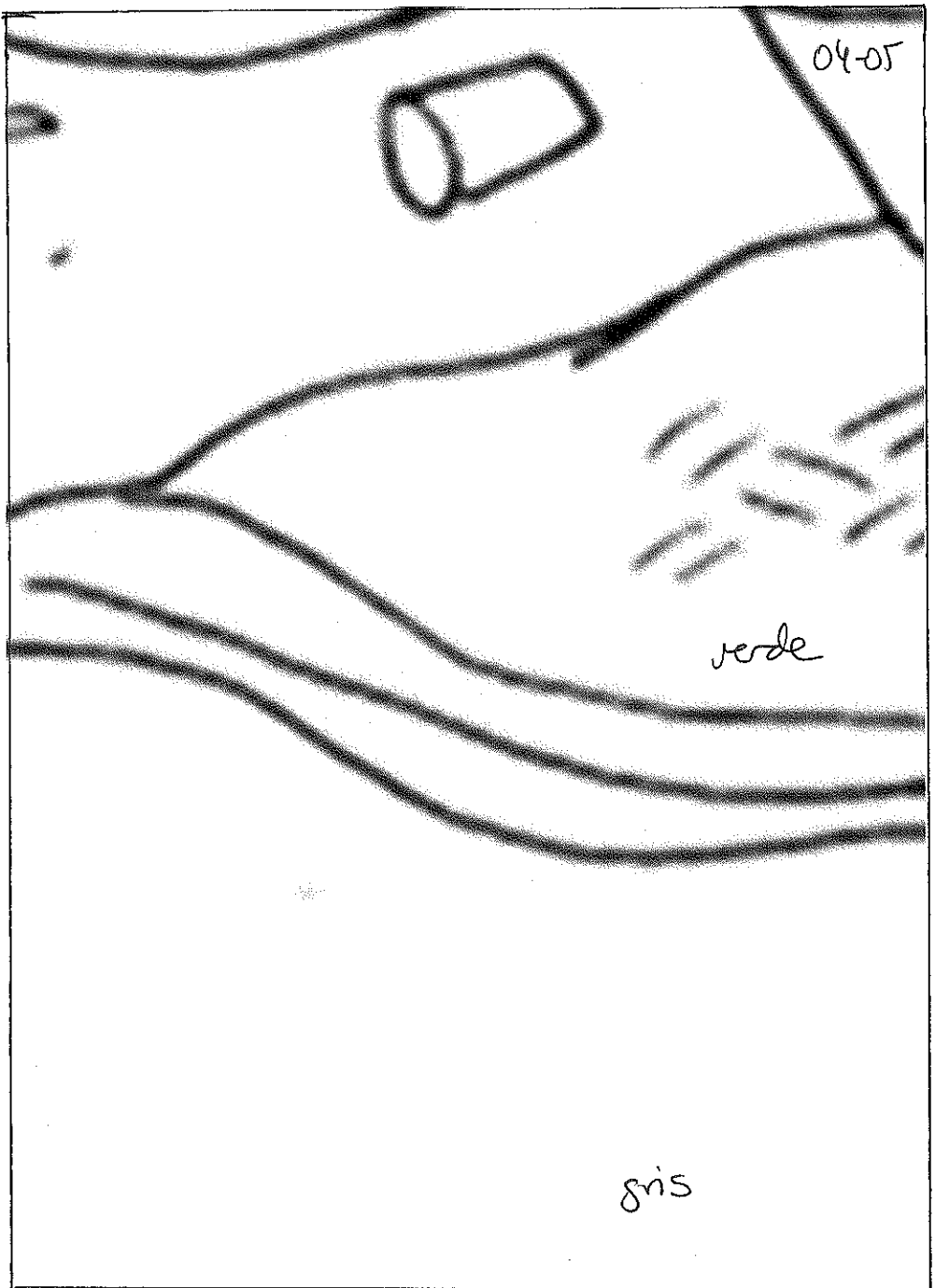

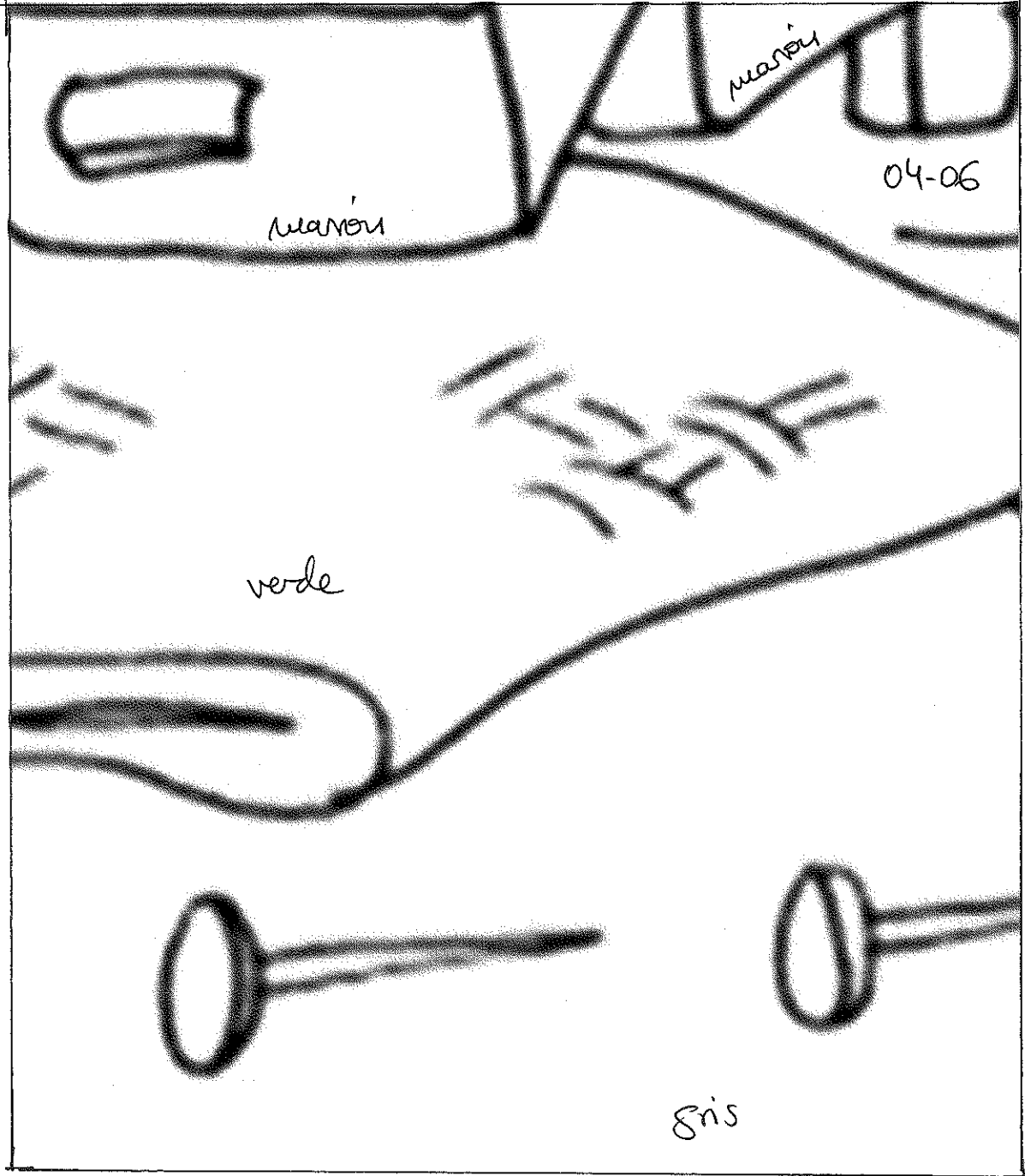

04-07

sis

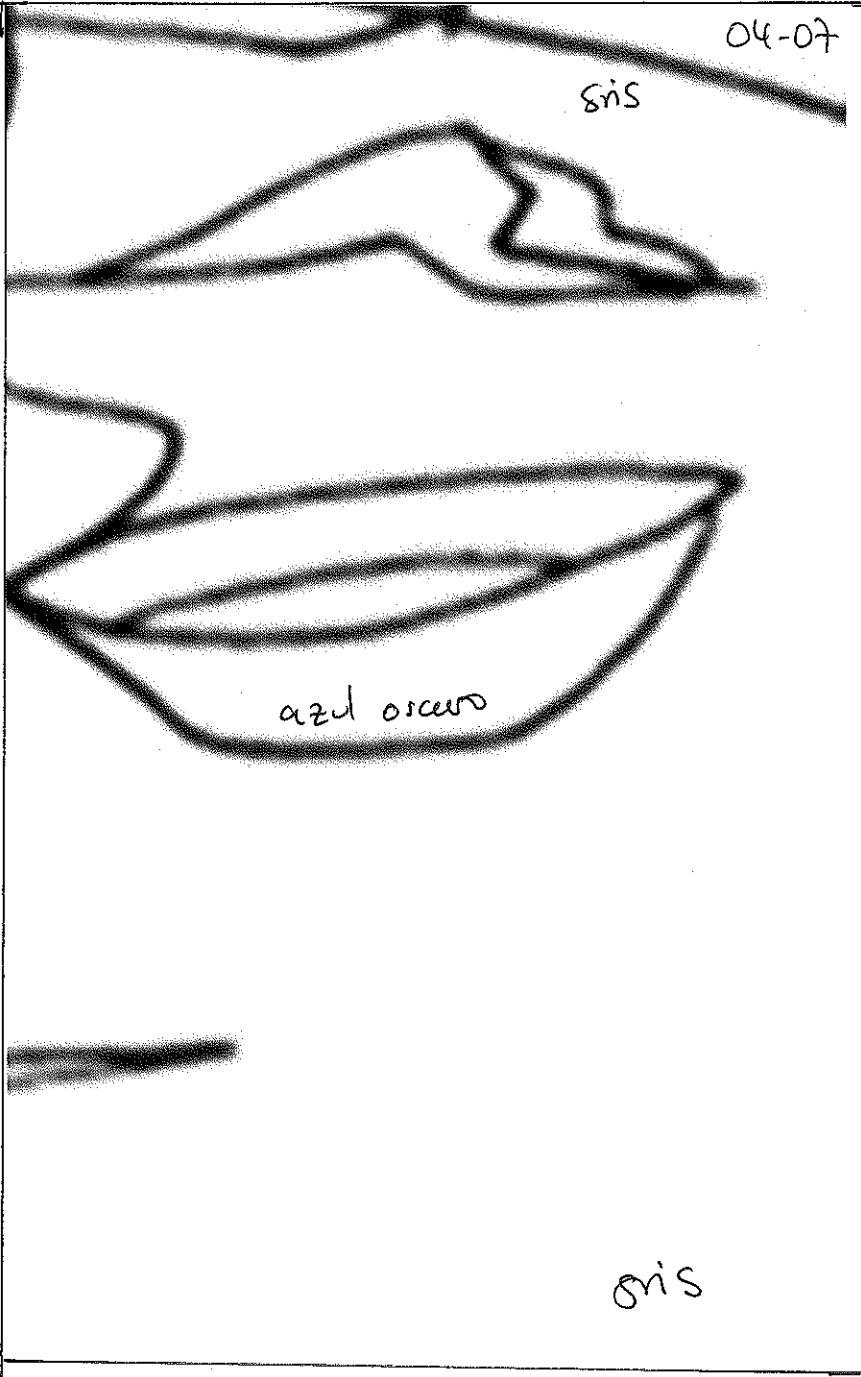

azul oscuro

sis